

Keep this Owner's Manual in the vehicle for handy reference whenever needed.



- We recommend that you also read the separate instructions for the equipment on your vehicle that was installed by your Isuzu Supplier.
- Your Isuzu Supplier will be glad to answer any questions you may have about the information in this manual.
- Please leave this manual in the vehicle when you resell it – the next owner will need it.

Notes on Reading This Manual

- Please read this manual carefully, especially the information in the "IMPORTANT INFORMATION" section and the instructions and information identified by the following

symbol/letter combinations:  DANGER ,  WARNING ,  CAUTION ,

 ADVICE and  NOTE . Among them,  DANGER ,

 WARNING and  CAUTION are reminders to be especially careful. Failure to follow or wrongly following the associated instructions could result in personal injury or accidents. Please read them thoroughly.

- Due to differences in vehicle specifications, the illustration used for description may not match your vehicle.

• The contents of this manual are current at the date of issue, but may differ slightly from your vehicle due to specification changes or other modifications made thereafter. QingLing Motors (Group) Co., Ltd. reserves the right to make changes at any time without prior notice.

- All rights reserved. This manual may not be reproduced in whole or in part, without the permission in writing of QingLing Motors Co.,Ltd.

Table of Contents

0	- Picture Index
1	- VEHICLE INFORMATION
2	- IMPORTANT INFORMATION
3	- DOORS, WINDOWS AND SEATS
4	- CONTROLS AND INSTRUMENTS
5	- COMFORT AND CONVENIENCE
6	- TIPS ON SAFE AND SMOOTH OPERATION
7	- SERVICE AND MAINTENANCE
8	- IN CASE OF EMERGENCY
9	- MAIN DATA

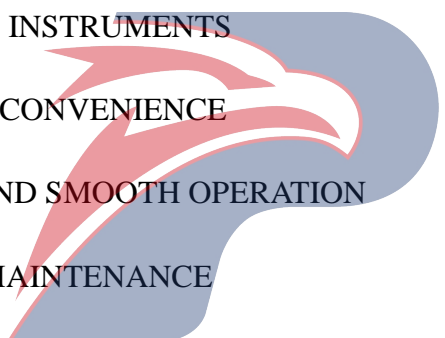

POWERSTAR

Notes on Reading This Manual



DANGER

Failure to follow these instructions identified by this symbol could result in death or serious injury to you and/or other people.



WARNING

Failure to follow these instructions identified by this symbol could result in a fire inside your vehicle in addition to death or serious injury to you and/or other people.



CAUTION

Failure to follow these instructions identified by this symbol could result in injuries or an accident.



ADVICE

Failure to follow these instructions identified by this symbol could cause malfunction or damage to your vehicle.



NOTE

This symbol identifies information that you need to know.

This symbol also identifies information that would be useful for operating the vehicle.

POWERSTAR

Abbreviations

This manual uses the following abbreviations, as interpreted below.

Abbreviations	Description
A/C	Air Conditioner
ABS	Antilock Brake System
ACEA	Association des Constructeurs Europeens d'Automobiles (Association of European Automobile Constructors)
API	American Petroleum Institute
ASTM	American Society for Testing and Materials
BS	British Standards
CAN	Controller Area Network
DIN	Deutsche Industrie Normen
EGR	Exhaust Gas Recirculation
FMVSS	Federal Motor Vehicle Safety Standards
GVW	Gross Vehicle Weight
JASO	Japanese Automobile Standards Organization
TATMA	The Japan Automobile Tyre Manufacturers Association
MIL	A United States Defense Standard (Military Standard)
PCV	Positive Crankcase Ventilation
PM	Particulate Matter
PTO	Power Take-Off
r/min	Revolutions per minute
SCR	Selective catalytic reduction
DVR	Driving Vehicle Record
QOS	Quicker of Start

• HOW TO USE THIS MANUAL	0-2
• PICTORIAL INDEX	0-3
• WARNING/INDICATOR LIGHT INDEX	0-12
• WARNING/CAUTION LABELS	0-17

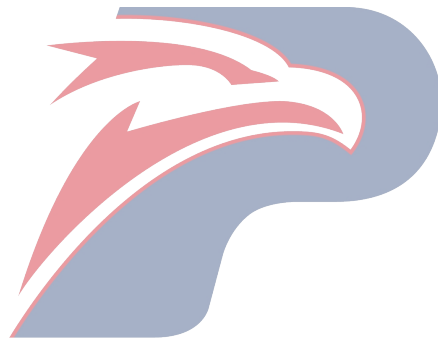

POWERSTAR

Chapter index tab

Chapter/section titles

Use this for quick access to your desired chapter.

These titles are useful for getting the gist of the content descriptions that follow at a glance.

The screenshot shows a manual page with the following content:

- 2-16 IMPORTANT INFORMATION** (with a left-pointing arrow)
- Driving** (with a left-pointing arrow)
- Check around the Vehicle before Starting the Engine** (with a left-pointing arrow)
- Text: "Before pulling away, perform a thorough safety check, making sure there are no children or obstructions around the vehicle." accompanied by an illustration of a truck and people.
- WARNING** (with a warning symbol): "Before starting the engine, make sure there is no flammable material under or around the vehicle. The presence of any such material could lead to a fire. If there is any wood within 50 cm (20 in) from the vehicle's heat source, it would represent a severe hazard as the wood could deform or discolor from the heat it could catch fire."
- Text: "Start the engine → Refer to page 4-4"
- Be Careful about Exhaust Emissions**
- WARNING** (with a warning symbol):
 - Exhaust emissions contain carbon monoxide, which is colorless, odorless and poisonous. If you inhale exhaust emissions, you may suffer carbon monoxide poisoning.
 - Do not keep the engine running for any length of time in a place that is poorly ventilated. It is particularly dangerous to run the engine in a garage or other indoor place that could easily fill with exhaust gases because you could suffer carbon monoxide poisoning.
 - Inspect the exhaust pipe from time to time. If you notice any abnormality (for example, a damaged joint, or a hole or crack caused by corrosion), have checks and maintenance performed by the nearest Isuzu Supplier. Continuing to use the vehicle without having the defect repaired would be dangerous because exhaust gases could get into the cab and cause carbon monoxide poisoning.
- Text: "WARNING (Continued)"

- DANGER
- WARNING CAUTION
- ADVICE NOTE

Symbols

See the preceding page for the meanings of these symbols.

Page

Refers you to a page (or pages) of this manual that concerns the present topic and that you should also read concerning the topic you are now reading.

Exterior

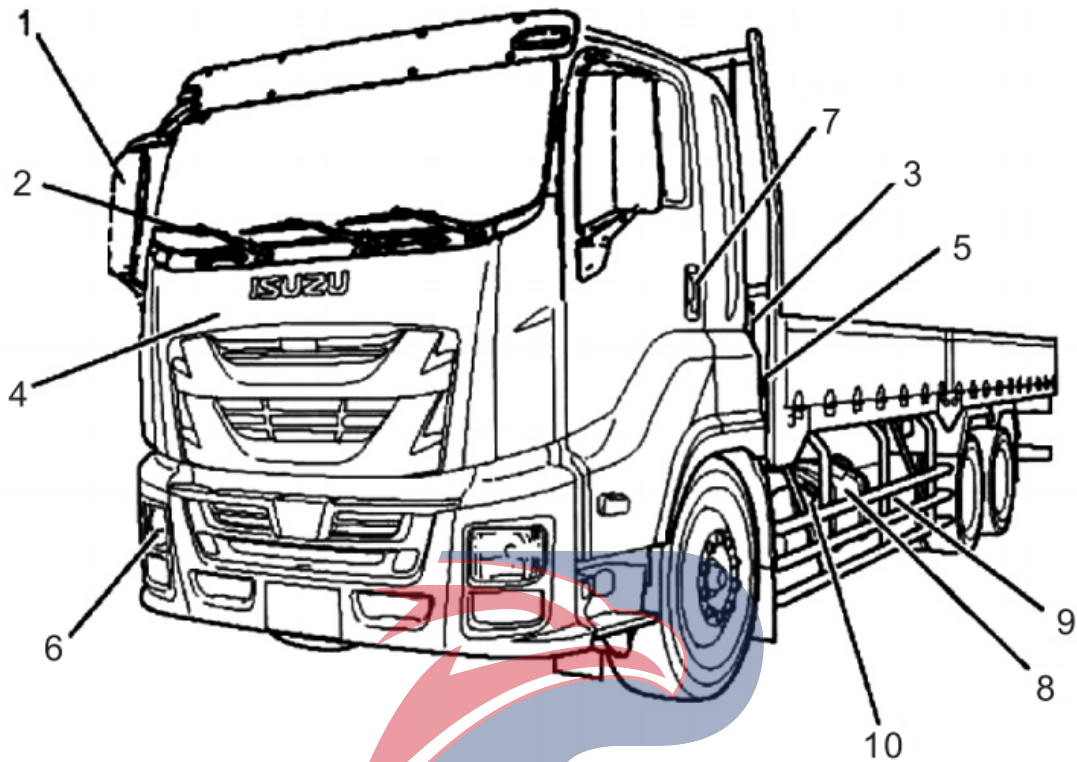

No.	Equipment	Page
1	Mirror	3-15
2	Replacement of wiper blade	7-115
3	Engine coolant	7-56
	The use of engine coolant	6-13
4	Front lid	7-9
	Windshield washer fluid	7-113
	Clutch fluid	7-104

No.	Equipment	Page
5	Driver cab tilting equipment	7-14
6	Replacement of light	8-29
7	Locking and unlocking of front door	3-3
8	Fuel feed port	3-8
9	Spare tire	7-88
10	Urea tank	3-9

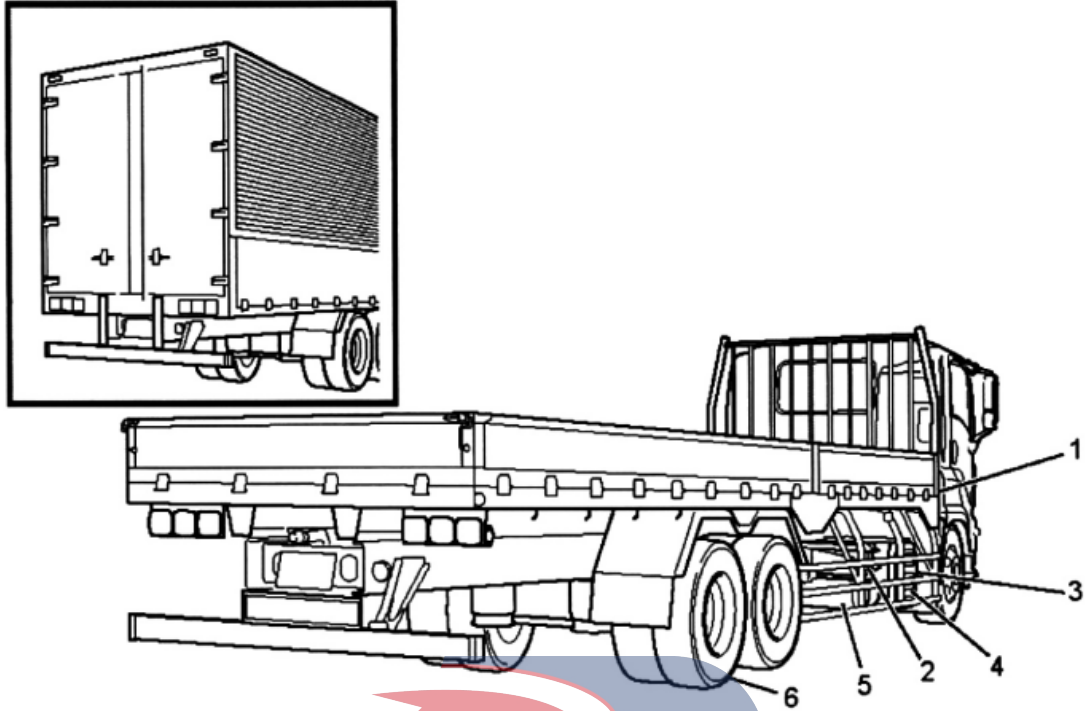

No.	Equipment	Page
1	Air filter	7-47
2	Battery	7-118
3	Air drier	7-96
4	Urea SCR system	4-100
5	Air tank	7-93

No.	Equipment	Page
6	Tire	7-72
	Replacement of tire (IS010 screw)	7-80
	Tire alignment	7-78
	Tightening of hub nut (IS010 screw)	7-87

POWERSTAR

Compartment

Dashboard peripherals

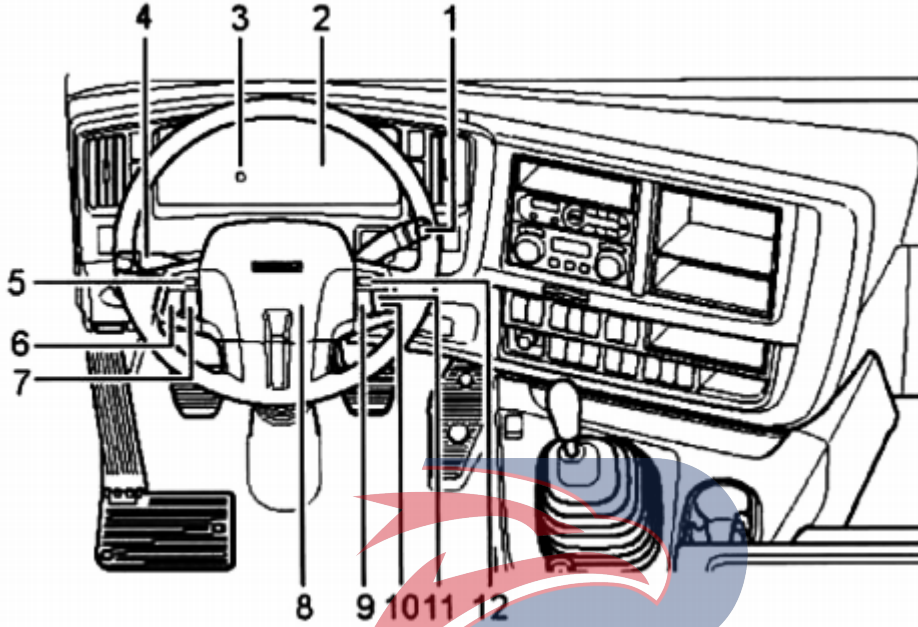

No.	Equipment	Page
1	Wiper switch	4-68
	The Hazard Switch	4-67
	Exhaust brake switch	4-94
2	Warning lamp/ indicator light arrangement	4-37
	Instrument display	4-9
	Multifunctional display screen	4-16
3	Select key of speedometer and odometer	4-10
4	Lighting switch	4-65
	Turn signal light switch (direction indicator)	4-66

No.	Equipment	Page
5	Acceleration/deceleration switch	4-87
	★	4-93
6	Main switch ★	4-86
7	Cancel switch ★	4-87
8	Speaker	4-70
9	MENU key	4-19
10	RETURN key	4-19
11	ENTER key	4-19
12	UP/DOWN Key	4-19

★ Denoting “configuration as per vehicle model” or “configuration as per order”

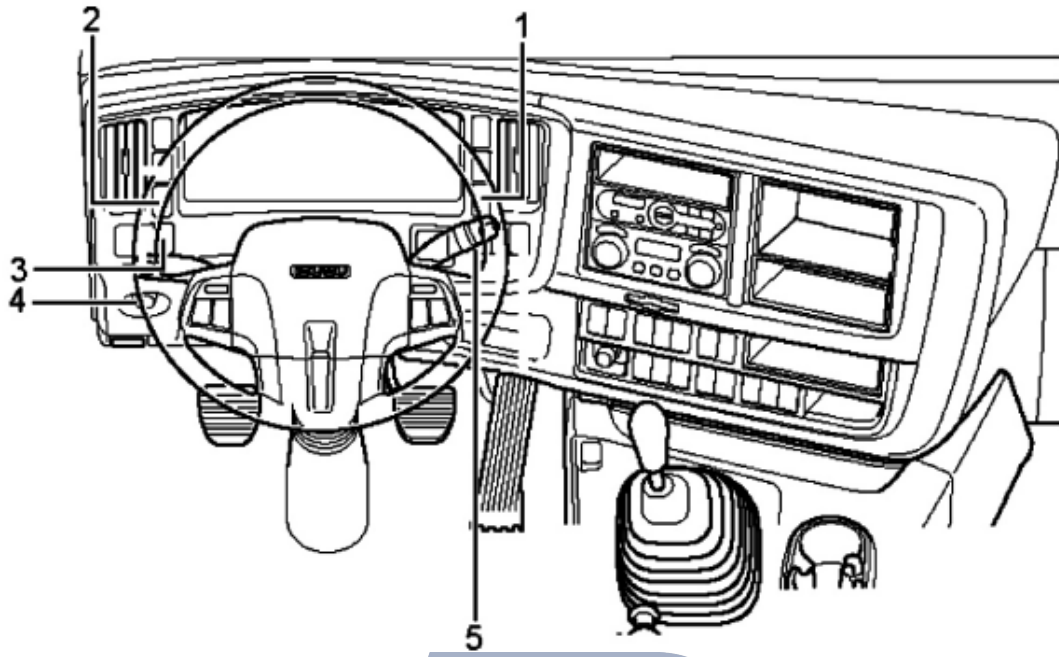

No.	Equipment	Page
1	Rearview mirror heating switch	4-70
2	Fog light switch	4-67
3	Headlight height control switch	
4	Idle speed control valve	4-64
5	Emergency contact switch	

POWERSTAR

Center console periphery

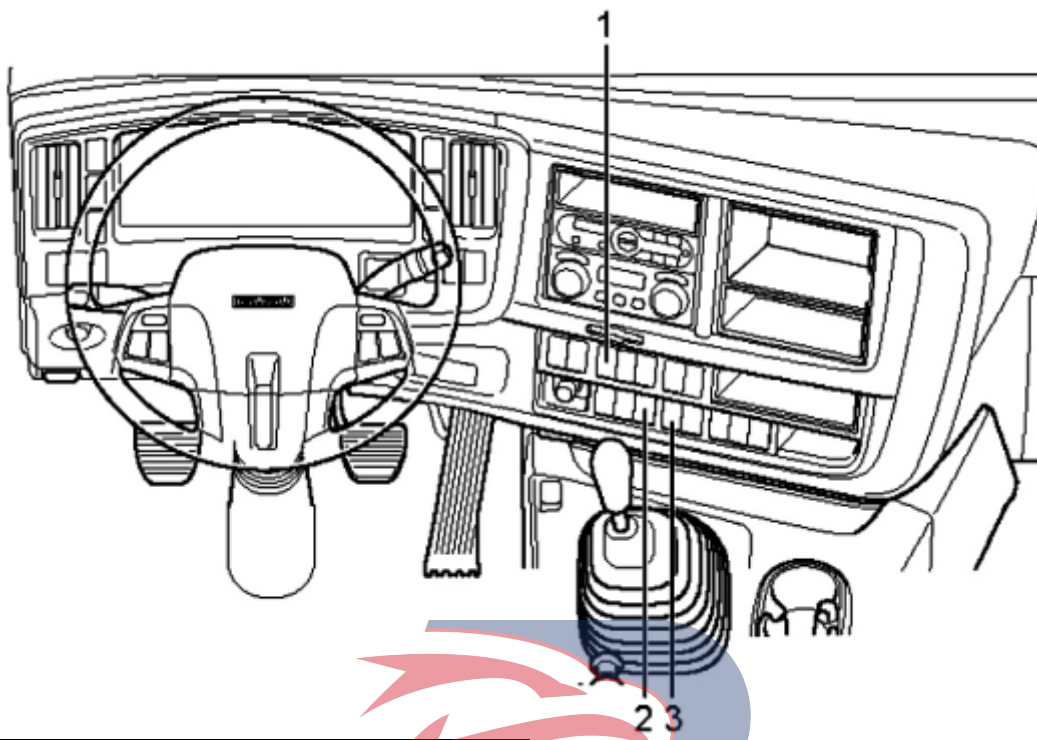

No.	Equipment	Page
1	HAZARD (warning switch)	4-67
2	Differential locking device switch ★	4-72
3	PTO switch ★	4-100

★ Denoting “configuration as per vehicle model” or “configuration as per order”

POWERSTAR

Center console periphery

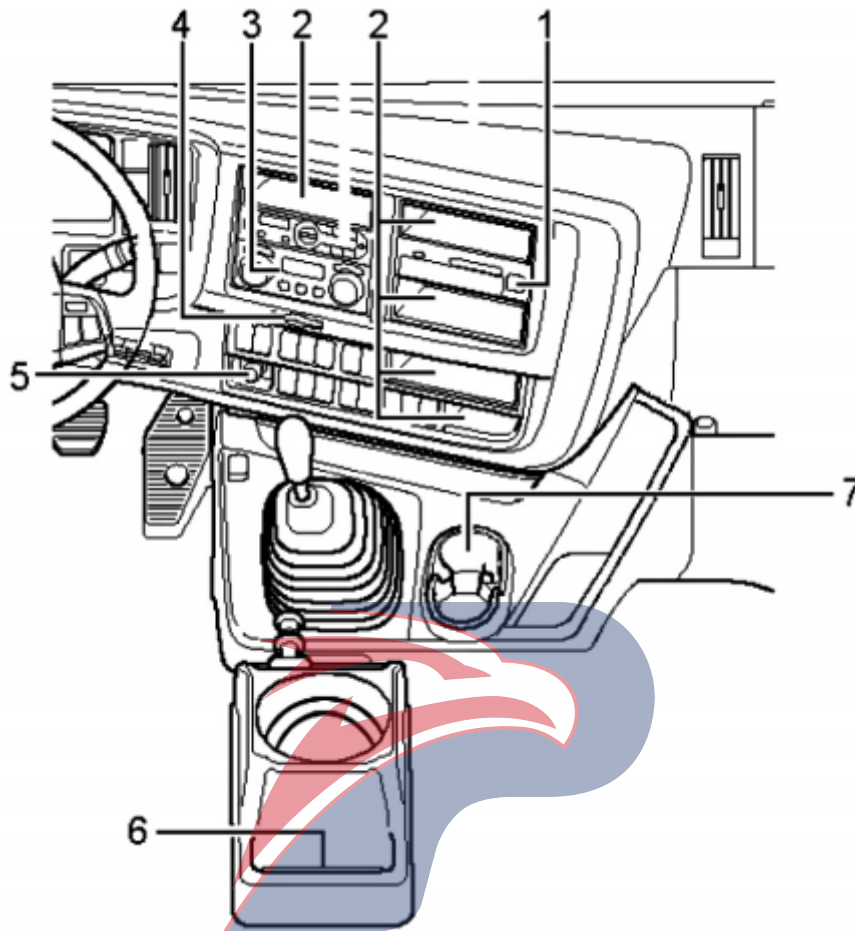

No.	Equipment	Page
1	DVR ★ Set STD/Low Roof in central control EXT roof in ceiling	4-60
2	Storage box (for small parts)	5-19

No.	Equipment	Page
3	Auto A/C controller	5-2
4	Card holder	5-19
5	Cigarette lighter	5-17
6	Seat side tray	5-19
7	Cup holder	5-21

★ Denoting “configuration as per vehicle model” or “configuration as per order”

Seats peripherals

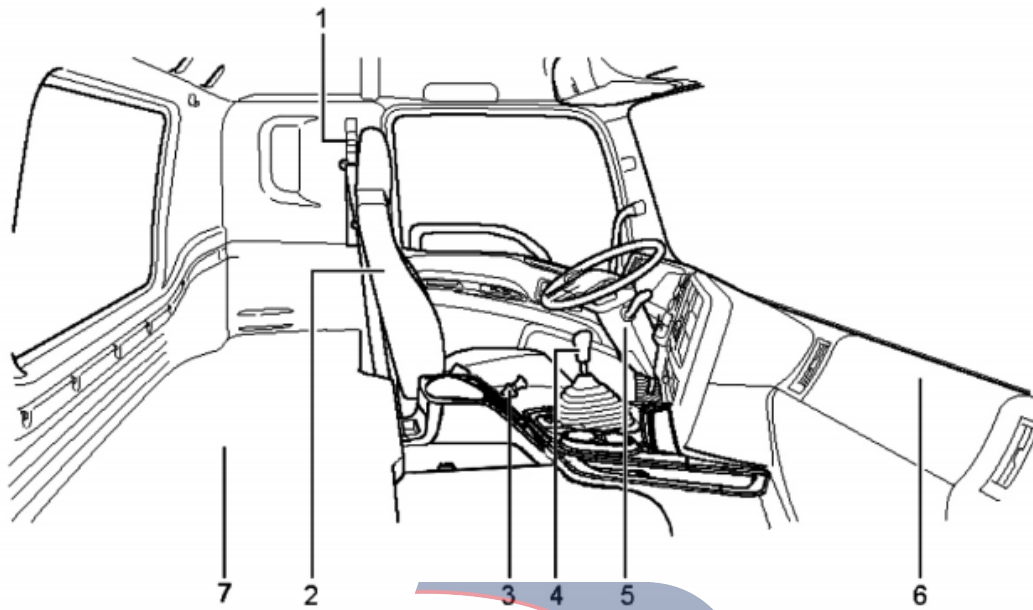

No.	Equipment	Page
1	Seat belt	3-17
2	Seat	3-12
3	Parking brake lever	4-75
4	Gearshift lever	4-76

No.	Equipment	Page
5	Fully adjustable steering	3-14
6	Fuse, relay box	8-37
7	Sleeper	5-24

POWERSTAR

Ceiling peripherals (Low Roof)

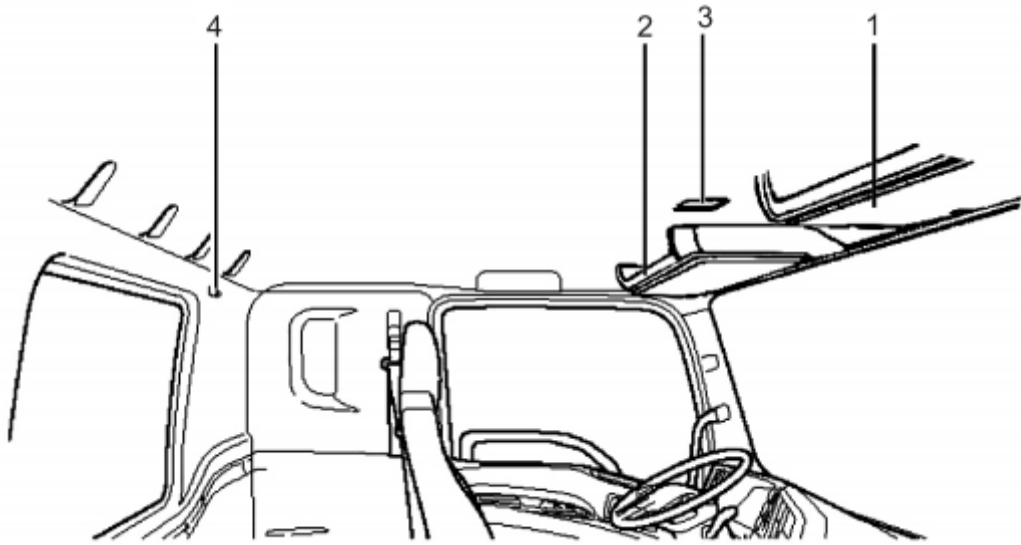

Ceiling peripherals (Standard Roof)

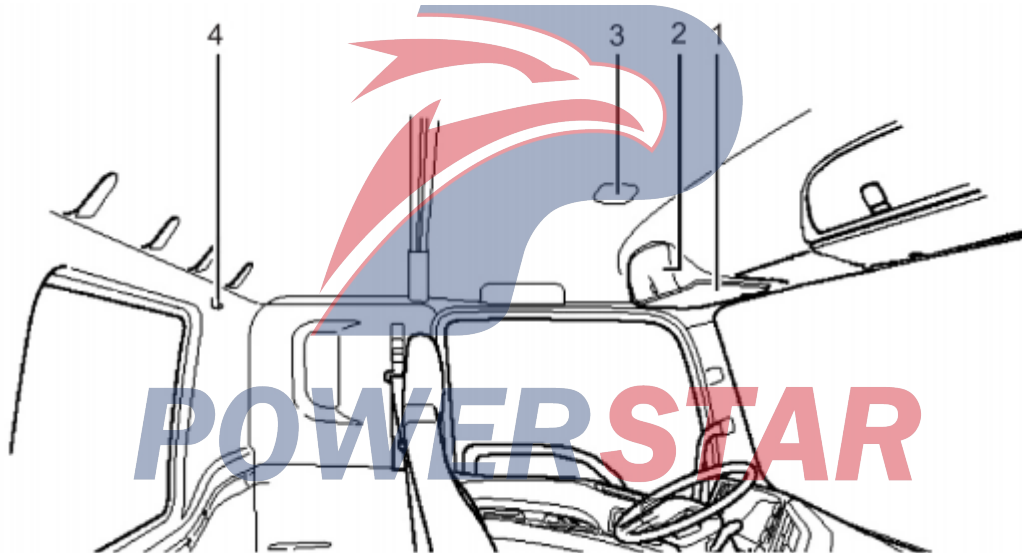

No.	Equipment	Page
1	Sun visors	5-16
2	Storage box (LOW)	5-20
	DVR (STD)	
3	Interior light	5-14
4	Hanger	5-22

Ceiling peripherals (High Roof)

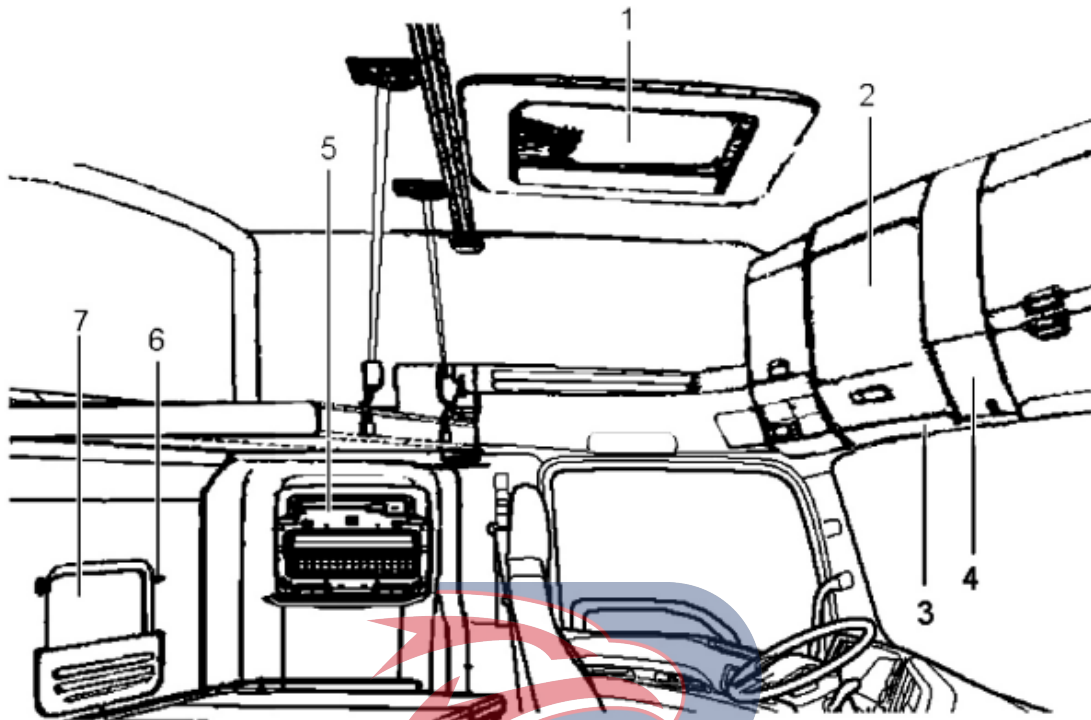

No.	Equipment	Page
1	Roof vent	5-23
2	Storage box	5-20
3	Sun visors	5-16













No.	Equipment	Page
4	Interior light	5-14
5	Tray table	5-23
6	Hanger	5-22
7	Rear storage box	5-23















POWERSTAR

Warning/Indicator Light Index









Multifunction Display

Warning and operation tips

Name	Display Information		Color	Page
	When parking	When driving		
Overheating	 <p>Overheating After cold engine running, close the engine and check engine coolant. Do not open the auxiliary fuel tank cap at high temperature to prevent scald.</p>	 <p>Please park the vehicle at a safe place. Overheating</p>	Red	4-45
Insufficient engine coolant	 <p>Insufficient engine coolant Supplement engine coolant after confirming no engine coolant leakage. Do not open the auxiliary fuel tank cap at high temperature to avoid scald.</p>	 <p>Please park the vehicle at a safe place. Insufficient engine coolant</p>	Red	4-44
Oil pressure abnormality	 <p>Oil pressure abnormality Please check the oil level. If the oil level is normal and there is no leakage, please consult an Isuzu supplier.</p>	 <p>Please park the vehicle at a safe place. Oil pressure abnormality</p>	Red	4-41
Charging abnormality	 <p>Charging abnormality Please check the belt. There is a risk of battery run-down. Please consult an Isuzu supplier.</p>	 <p>Please park the vehicle at a safe place. Charging abnormality</p>	Red	4-42
Fuel filter (drainage)	 <p>Fuel filter Existence of moisture and deposits in the fuel filter. Please discharge water.</p>	 <p>Please park the vehicle at a safe place. Fuel filter</p>	Red	4-43
Load limiting	 <p>Load limiting The current oil temperature is high; in order to protect the engine, the output has been limited. When the oil temperature returns to normal, load limitation will be eliminated.</p>	 <p>Load limiting</p>	Amber	4-56

Name	Display interface		Color	Page
	When parking	When driving		
Voltage abnormality (relatively low voltage)		Low voltage	Red	4-57
Voltage abnormality (too high voltage)		Too high voltage	Red	4-57
Low voltage notes	 Low voltage notes Please inject air.	 Low voltage notes	Red	4-39
ABS abnormality		ABS	Amber	4-39
Forget to restore the hand brake		 Forget to restore the hand brake	Red	4-57
Urea injection abnormality	 Urea injection abnormality The urea injection system is abnormal. Please consult an Isuzu supplier.	 Urea injection abnormality	Amber	4-56
Urea replenishing	 Urea replenishing Please replenish the designated urea. When there is no urea, the engine cannot be restarted.	 Urea replenishing	Amber	4-56
Refueling		Refueling	Amber	4-51
PTO running		PTO running	Red	4-54
Automatic cruise mode		Automatic cruise mode	Green	4-82
Variable SLD mode (variable speed limiter)		Variable SLD mode	Green	4-88

Maintenance information





Name	Display information		Color	Page
	When parking	When driving		
Engine oil & filter		Engine oil & filter Needing to be replaced	Amber	4-46
Fuel filter		Fuel filter Needing to be replaced	Amber	4-47
Gearbox gear oil		Gearbox gear oil Needing to be replaced	Amber	4-46
Differential gear oil		Differential gear oil Needing to be replaced	Amber	4-57
Power steering fluid		Power steering fluid Needing to be replaced	Amber	4-48
Compressed air dryer		Compressed air dryer Needing to be replaced	Amber	4-48
Tire replacement		Tire replacement Needing to be replaced	Amber	4-49
Starter		Starter Needing to be replaced	Amber	4-49



POWERSTAR

Instrument panel



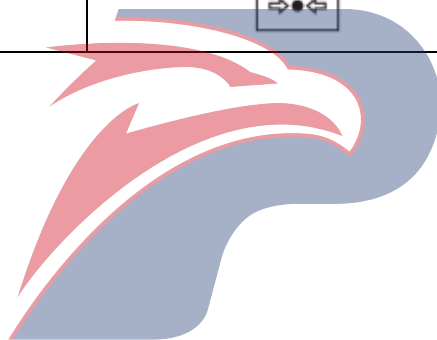

Warning lamp contents

Name	Warning Lamp	Color	Page
Check engine warning lamp		Amber	4-42
Parking brake warning lamp		Red	4-40
Brake warning lamp		Amber/Red	4-38
Air pressure warning lamp		Amber	4-39



POWERSTAR

Indicator lamp contents

Name	Warning Lamp	Color	Page
QOS lamp		Amber	4-53
Differential locking device indicator lamp		Amber	4-53
Turn lights & Hazard lamp (left)		Green	4-51
Turn lights & Hazard lamp (right)		Green	4-51
High beam indicator lamp		Blue	4-52

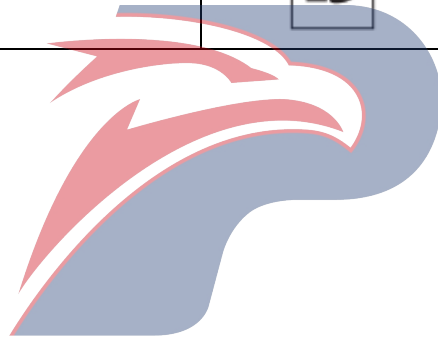

POWERSTAR

WARNING LABELS

- The warning/caution labels in your vehicle indicate very important instructions and information that you should respect to ensure safe and proper use of the vehicle. Be sure to read them before using the vehicle.
- If any of these labels are peeling or illegible due to wear or scratches, please contact your Isuzu Supplier for a replacement.
- These warning/caution labels only concern the vehicle, not any additional installation. If your vehicle is equipped with a special body, check the instruction manual from the body manufacturer for warning/caution labels, if any.
- Some examples of warning/caution labels are indicated on the following pages, but there are many others not shown. Also, the contents of these labels may vary from model to model.
- The warning/caution labels indicated may be located differently in your vehicle.

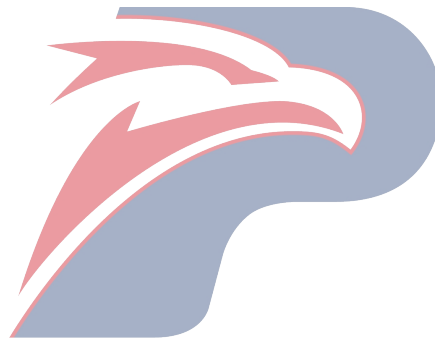

POWERSTAR

Warning/Caution Labels – Cab Interior

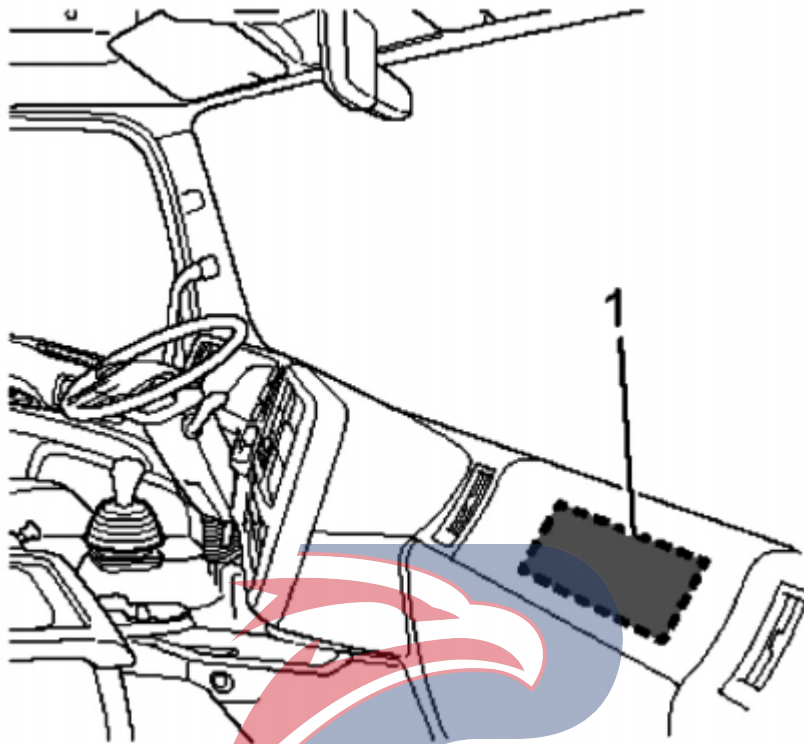

No	Description
1	Fuse Box

POWERSTAR

Warning/Caution Labels – Cab Exterior

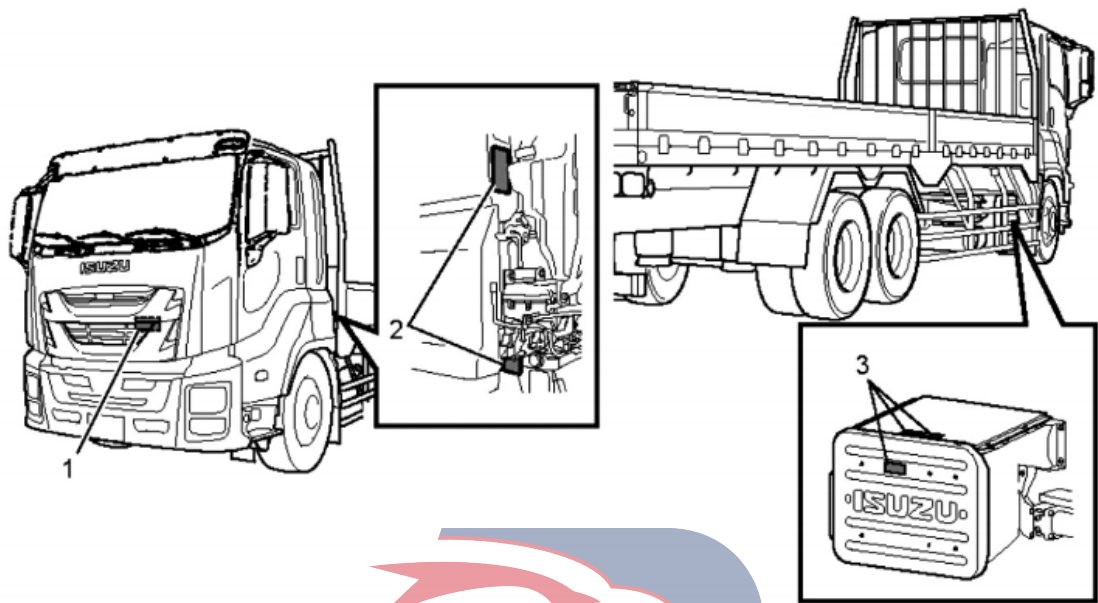

No	Description
1	Engine oil
2	Cab tilt
3	Urea SCR

POWERSTAR

Warning/Caution Labels (Use instructions of hand brake and trailer brake)

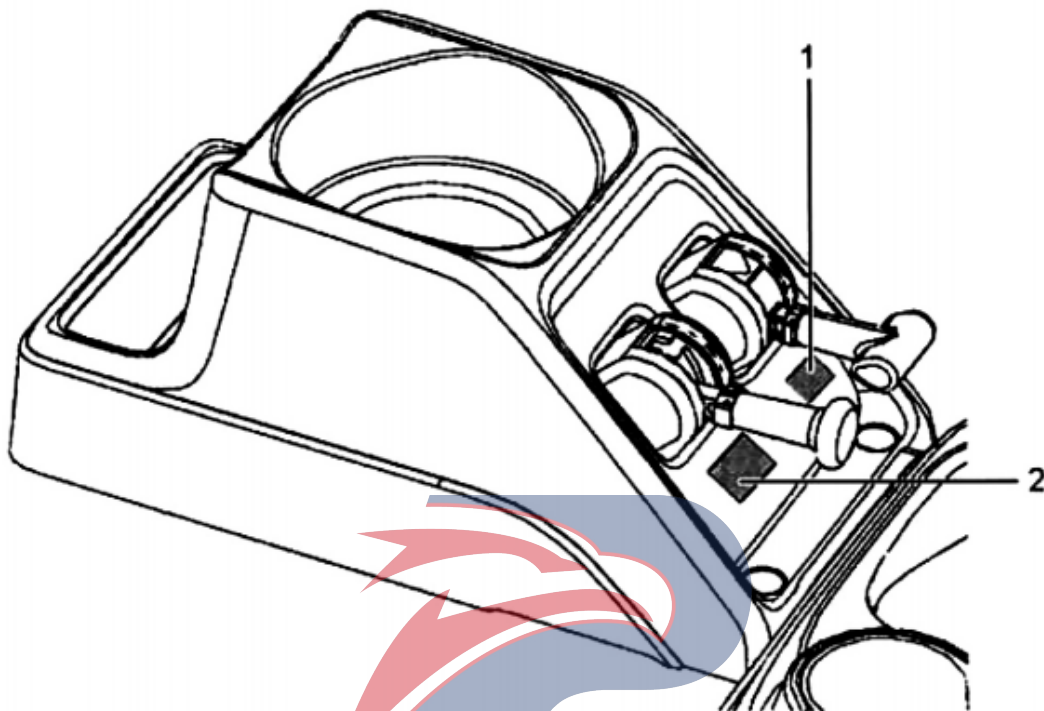

No	Description
1	Use instructions of trailer brake
2	Use instructions of hand brake

POWERSTAR

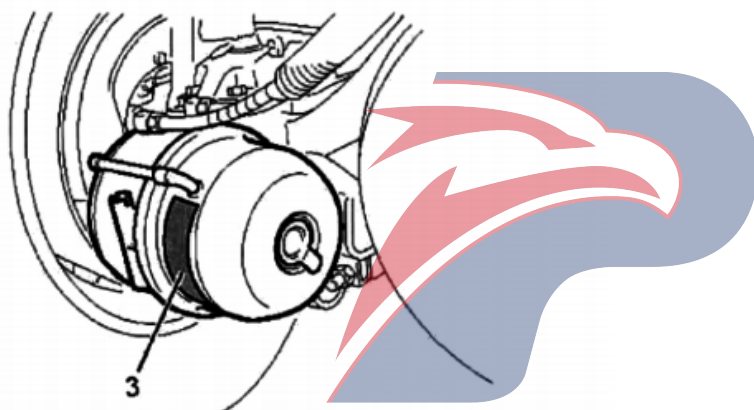
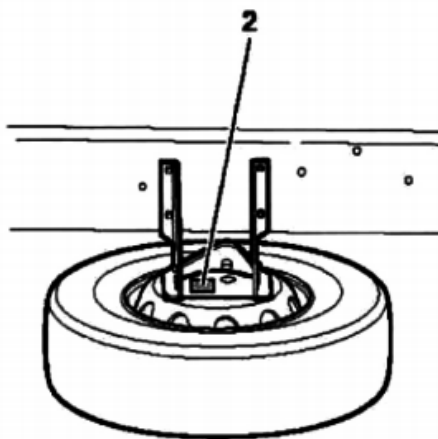
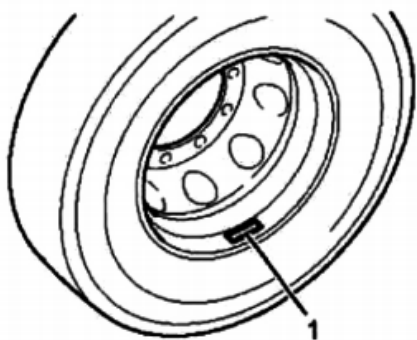

POWERSTAR

No	Description
1	ISO wheel identification number
2	Spare tire
3	Brake chamber

Warning/Caution Labels - Engine Compartment

6UZ1 Engine

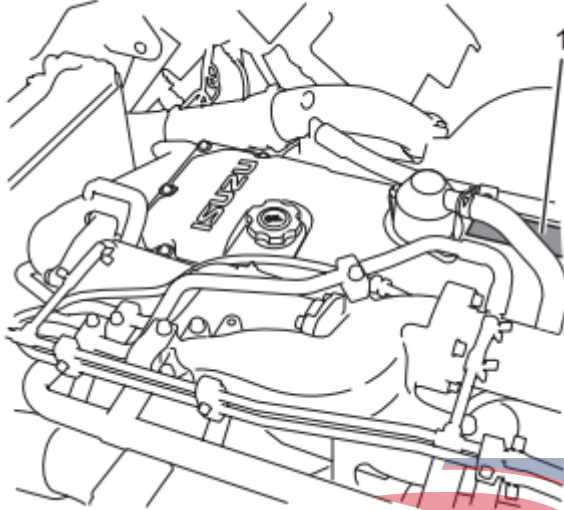

No	Description
1	Engine tuning table and engine model

6WG1 Engine

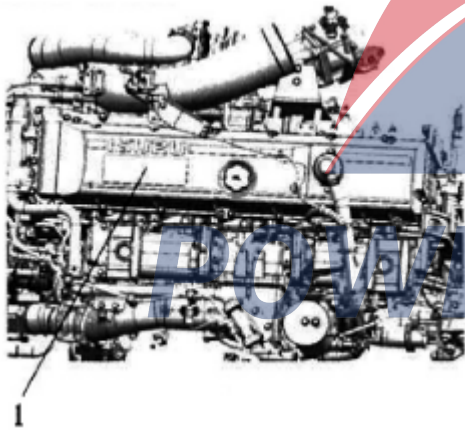

ERSTAR

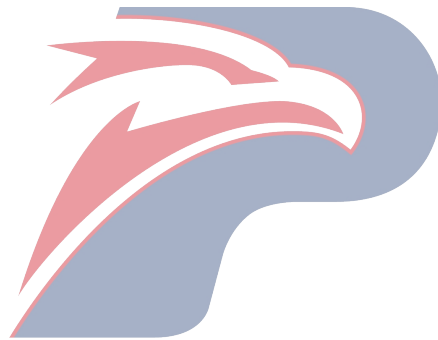

POWERSTAR

Vehicle Identification Number (VIN) and Engine Numbers

The VIN and engine number are necessary for registering your vehicle. They are also necessary when your vehicle undergoes official inspections. Provide your Isuzu Supplier with these numbers when you are having the vehicle repaired or are ordering replacement parts. The Supplier will be able to do the requested jobs more competently and quickly.

VIN

VIN location on frame

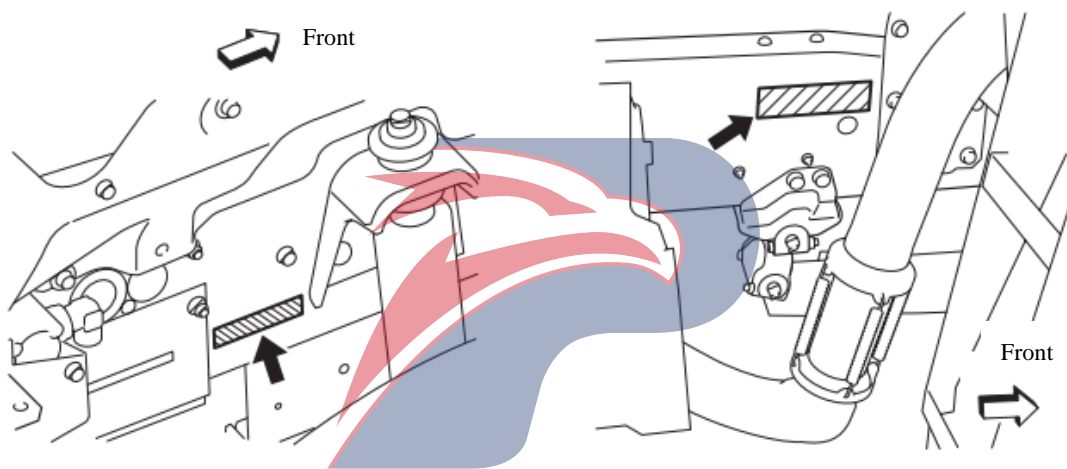

ID plate

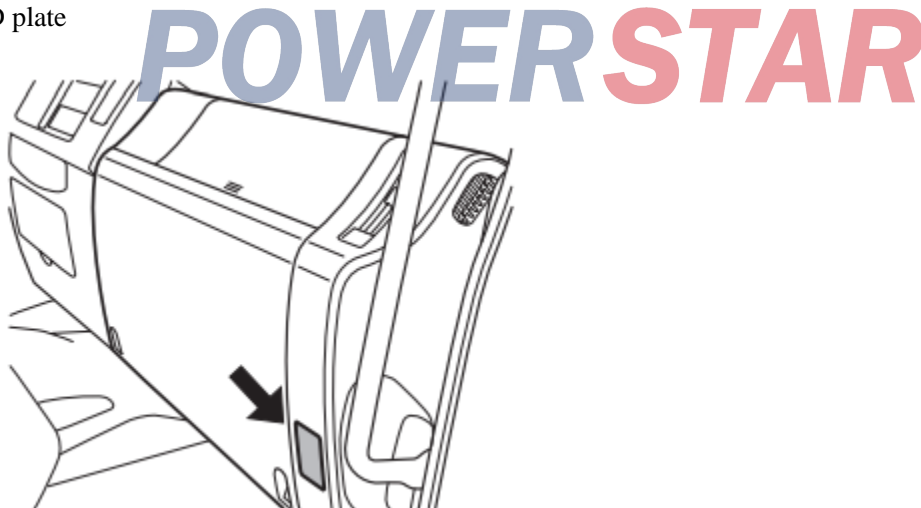

The ID plate at the lower part of the dashboard indicates the VIN together with other information such as the option code.

The ID plate indicates the VIN. This single number contains multiple pieces of information including the vehicle and engine model codes as shown below.

L	W	L	Y	B	G	Y	K	5	E	L	0	0	0	0	5	6
1	2	3	4	5	6	7	8	9								

No	Description	
1	World Manufacturer Identifier (WMI) LWL: China Qingling	WMI
2	Vehicle model code Y: VC61 series heavy-duty goods vehicle	Vehicle description part
3	Gross vehicle mass, axle load B: axle load (22001Kg~30000Kg)	
4	Driving type code, engine code AY: 4X2 6UZ1-TCG40 AT: 4X2 6WG1-TCG50 DY: 6X2 6UZ1-TCG40 DT: 6X2 6WG1-TCG50 FY: 6X4 6UZ1-TCG40 FT: 6X4 6WG1-TCG50 GY: 8X4 6UZ1-TCG40 GT: 8X4 6WG1-TCG50 AS: 4X2 6WG1-TCG51 AP: 4X2 6WG1-TCG52 DS: 6X2 6WG1-TCG51 DP: 6X2 6WG1-TCG52 FS: 6X4 6WG1-TCG51 FP: 6X4 6WG1-TCG52 GS: 8X4 6WG1-TCG51 GP: 8X4 6WG1-TCG52 AU: 4X2 6UZ1-TCG50 AZ: 4X2 6UZ1-TCG51 DU: 6X2 6UZ1-TCG50 DZ: 6X2 6UZ1-TCG51 FU: 6X4 6UZ1-TCG50 FZ: 6X4 6UZ1-TCG51 GU: 8X4 6UZ1-TCG50 GZ: 8X4 6UZ1-TCG51	
5	Body type (wheel base) code K: flat-face cab, (wheel base: G900mm~5500mm)	
6	Check digit	
7	Model year code E: 2017	Vehicle indication part
8	Manufacturer code L: QingLing Motors Co., Ltd.	
9	Chassis number	



ADVICE

- Interpretation of the VIN may differ depending on the market. For further details, please ask your Isuzu Supplier.

• Before Driving	2-2
• Carrying Children	2-12
• Driving	2-14
• Stopping and Parking	2-23
• Phenomenon to be noticed	2-28
• Notes for fault prevention	2-31
• Phenomenon which needs the contact with ISUZU supplier	2-33
• Urea SCR system	2-35
• Vehicle attached with speed limiter	2-38

This chapter contains information and cautions that you should observe for safe and comfortable vehicle operation. Be sure to read it before using the vehicle.

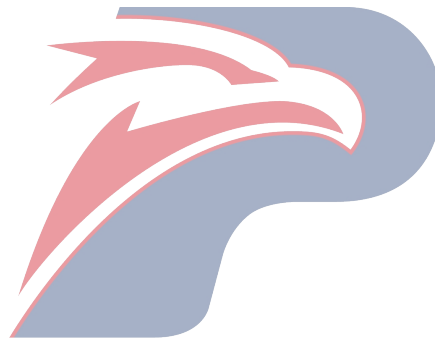

POWERSTAR

Before Driving

Routine inspection (before driving)

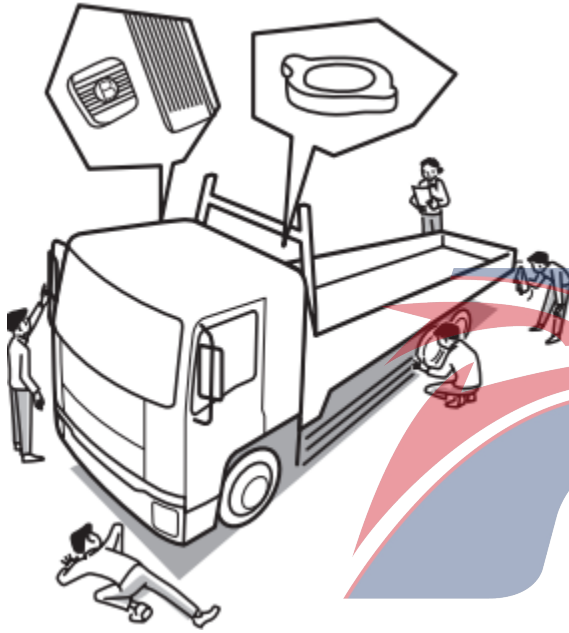

Routine inspection is the driver's obligation specified by the Road Transport Vehicle Act. Before driving, please do a routine check, to ensure that there is no abnormality. For safe and comfortable driving, keep a record of the distances driven and the condition of the vehicle during operation. Perform inspections at appropriate intervals, and perform maintenance in accordance with the findings of the inspections.

If an inspection reveals an abnormality or there was an abnormality the previous time the vehicle was driven, have the vehicle repaired by your Isuzu Supplier before it is driven again.

POWERSTAR

Inspected equipment	Check item	Page
Brake	Pedal distance (pedal free play)	7-69
	Brake pedal free play	7-69
	Exhaust sound from brake valve	7-69
	Increase in air pressure	7-91
	Operation of parking brake lever	7-70
Clutch	Action * 2	7-102
Tire	Air pressure	7-73
	Cracks and other damage	7-75
	Abnormal wear	7-75
	Tread depth*1	7-75
	Disc wheel mounting condition	7-77
Battery	Battery fluid level*1	7-120
Engine	Engine coolant level*1	7-58
	Engine oil level*1	7-38
	Engine startability, abnormal noise*1	7-37
	Deceleration and acceleration state * 1	7-37
	Loosening and damage of fan belt *1	7-52
Lighting device, direction indicator	Illumination, flashing or stained or damaged lights	7-117
Wiper and window cleaning agent	Wiping state * 1	7-115
	Liquid level, injection state * 1	7-113
Air tank	Condensation in air tank (draining water)	7-93
Air drier	Function * 2	7-96
Fault position while driving	Determine whether this position is abnormal or not	7-35

*1: It shows the items which are required to be inspected at appropriate time upon running distance or running condition.

*2: It shows the inspection items recommended by QingLing Motors Co., Ltd.

Whether to Use the Specified Fuel



CAUTION

- The use of the fuel other than ultralow sulfur diesel and low sulfur diesel may have an adverse effect on engine and exhaust gas cleaning equipment (urea SCR) and cause fault. If you accidentally put the wrong fuel in the tank, drain it all out. Engine Starting Method with the wrong fuel in the tank could result in a fire or engine damage.
- Using diesel fuel other than low-sulfur diesel fuel or low-sulfur diesel fuel could prevent the vehicle from complying with local legal requirements.
- Open the fuel tank filler cap slowly. If you open it quickly, fuel may spurt out.



ADVICE

- Be sure to use low-sulfur diesel fuel or low-sulfur diesel fuel.
- The ultralow sulfur diesel (sulfur content less than 50ppm) is recommended. If you supply the vehicle with poor-quality fuel, water-removing additive or other additive, gasoline, kerosene or alcohol-based fuel, it could harm the fuel filter, prevent proper movement of fuel-lubricated parts in the injectors and adversely affect the engine and PM catalytic converter possibly resulting in a breakdown.



NOTE

- The specifications of diesel fuel differ according to the climate and region.

Fuel Tank Filler Cap→Refer to page 3-8

Fuel→Refer to page 6-14

Load Cargo Correctly

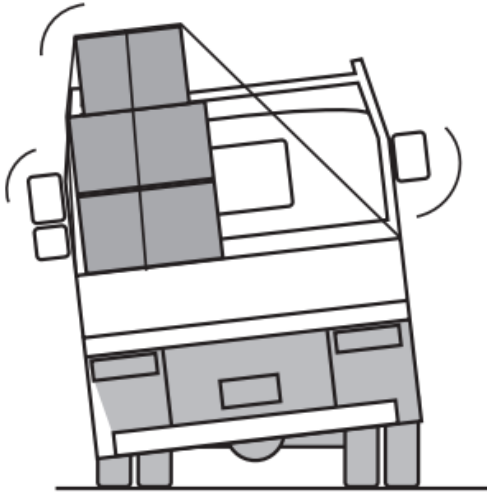





**WARNING**

- Overloading can result in an accident because it places too much strain on the wheel bolts with the result that they break and the wheels come off.

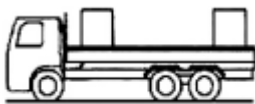
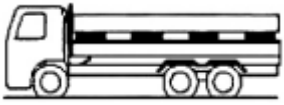
**CAUTION**

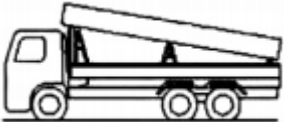
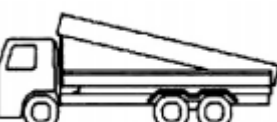
- It is extremely dangerous to overload the vehicle or to load the vehicle with the cargo positioned on one side. Load the vehicle correctly, observing the maximum loading capacity. Incorrect loading can make the cargo unstable. It can also cause overload condition confined to a small area, resulting in damage to the cargo bed and frame.
- Overloading places undue strain on vehicle parts. It can shorten the vehicle's service life and cause an accident.

POWERSTAR

Precautions while loading	Correct	Wrong
Do not place cargo only at the front or only at the rear. Distribute it evenly.		
When using supports under cargo, position them uniformly along the cargo.		
To the greatest extent possible, do not allow long cargo to protrude beyond the rear edge of the cargo bed. Rather, use supports to raise it at an angle. Avoid supporting it using just the front guard frame and the rear edge of the cargo bed.		
Use ropes and tarpaulins to secure the cargo so it does not fall off the cargo bed. Use rubber bands or bungee cords to prevent the tarpaulins from flapping in the wind.		
Avoid loading cargo too high. It can cause the vehicle to tip sideways when it catches sidewinds and when turning the vehicle.		

Loading Heavy Cargo

POWERSTAR

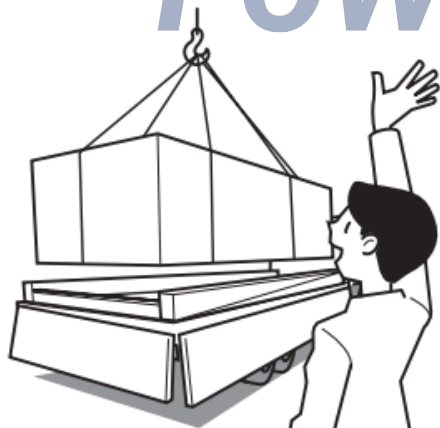
**CAUTION**

- When the cargo is heavy, take steps to prevent it from slipping and secure it with wire cables.

Do Not Secure Cargo Too Tightly



 **ADVICE**

- To prevent cargo from falling off the cargo bed, it is essential to secure it with ropes and tarpaulins. However, retaining it too tightly can damage the cargo bed's gates and front guard frame.

Make Sure There is No Flammable Material between the Cab and Cargo Bed



 **WARNING**

- Be careful not to allow the ends of ropes or edges of tarpaulins to come lower than the heat protector at the back of the cab. During vehicle operation, the engine's heat could set them on fire. Carefully secure the ends of ropes and edges of tarpaulins.

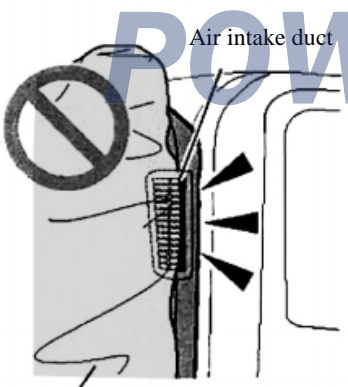

 **ADVICE**

- In order to prevent the cover cloth or hood jamming the air intake duct, please fix it with rubber, etc. In the case that the air intake duct is jammed, the engine will be adversely affected to cause inadequate output power and other faults.

Cover cloth, hood

Economical Driving



Driving too fast, driving so slowly that the engine knocks, driving with the exhaust brake switched on all the time, and frequently using the exhaust brake to adjust your speed lead to poor fuel economy. To the greatest extent possible, drive at a constant speed.

When accelerating, increase your speed gently and slowly, and upshift early. Warming up the engine for longer than necessary and revving the engine are a waste of fuel. Driving with the vehicle overloaded is also a waste of fuel.

Frequently check the tire pressures and make sure they are always correct.

Unloading Cargo

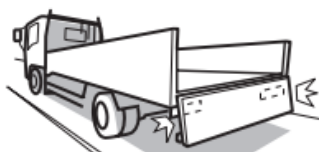

CAUTION

- When you load or unload cargo at the roadside and the cargo bed's gates or other body parts obscure the tail lights, stop lights, hazard warning flashers, turn signal lights and/or reflectors, be sure to warn other drivers and road users by placing signs or emergency warning triangles where they are easy to see.
- When you load or unload cargo at the roadside, select a place where stopping and parking are allowed and other drivers and passersby will not be inconvenienced.

Do Not Carry Fuel and Spray Cans in the Cab



WARNING

- It is extremely dangerous to carry fuel and spray cans in the cab. If such a container were to ignite or rupture, it could cause a fire or explosion.

Keep the Floor around the Driver's Seat Clean and Tidy



WARNING

- It is extremely dangerous to have empty cans, empty bottles or other items rolling around on the floor because they could get trapped under the brake pedal and prevent brake application. For proper pedal operation, it is also essential to lay floor mats properly. Otherwise, secure operation of each pedal cannot be performed.
- Do not use the dashboard pocket or the top of the dashboard as a place to put items that could roll, which could interfere with your driving.

Whether the floor mat is laid properly

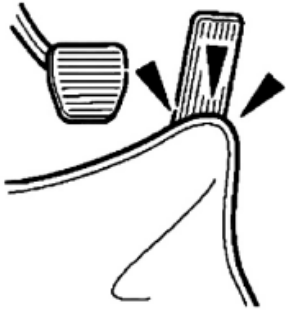

WARNING

- Please lay the floor mat appropriate to the vehicle model. If the pedal is covered or the floor mat is re-laid, the floor mat may hang on each pedal to affect the vehicle operation and cause the safety accident.

Correct Driving Posture

WARNING

- Before driving, be sure to adjust the seat, steering wheel and mirrors to positions that give you a correct driving posture. Make sure the seat is securely retained by trying to rock it forward and backward, and put on the seat belt. All other passengers must wear seat belts.

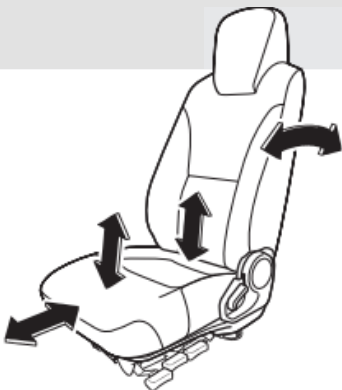

- Seat → Refer to page 3-12
- Seat Belt → Refer to page 3-17
- Mirror → Refer to page 3-15

Seat Adjustment

Adjusting the seat for a correct driving posture is a fundamental part of safe driving.



Latch
Buckle

Seat belt

Be sure to wear your seat belt. Sit up straight with your lower back pressed against the seat and the lap belt as low on your hips as possible.



Low to hip bone as possible



Seat adjustment recommendations	
a	Make adjustments that allow you to easily turn the steering wheel with your elbows slightly bent.
b	Position the seatback so it is always touching your shoulders.
c	Make sure you can adequately press each pedal.

	Seat belt fastening cautions	Causes
A	Position the lap belt as low on your hips as possible.	The pressure applied by the seat belt in a collision would be dangerous if the belt is positioned incorrectly.
B	Position the shoulder belt so it is on your shoulder (not touching your neck chin or face).	
C	Make sure the seat belt is not twisted when you put it on.	To ensure that the seat belt is fully effective.

Passengers and Seat Belts

Only one person should use each seat belt.



WARNING

- Be sure to adjust the seat before driving. Achieve the correct driving posture, gently rock the seat to make sure it is locked in place, and put on your seat belt before you start driving. In addition to the driver, all other passengers must wear seat belts.
- For a child who is so small that the seat belt touches his/her face or does not rest across his/her hips, use a child seat or other suitable restraint, not the seat belt. Using the seat belt could be dangerous.

Carrying Children → Refer to page 2-12

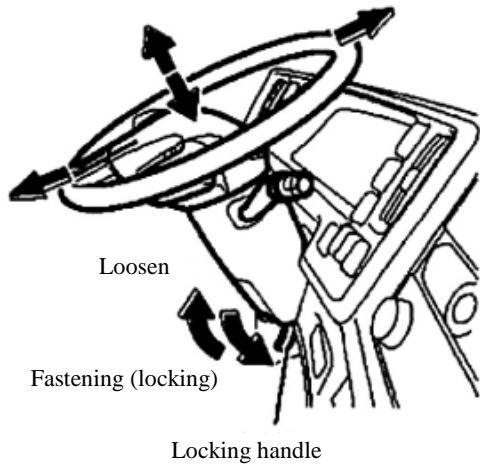

Adjusting the Position of the Steering Wheel

You can adjust the position of the steering wheel in the up-down and fore-aft directions. After making an adjustment, make sure the steering wheel and lock lever are securely locked.

 **WARNING**

- When you have adjusted the steering wheel, try pulling the steering wheel up and down to check that it is securely locked in position before driving.
- Adjust the position of the steering wheel **before** you start driving. Adjusting the position of the steering wheel while driving would be extremely dangerous because the steering wheel would rattle up and down, preventing precise steering.

Fully Adjustable Steering→Refer to page 3-14

Carrying an Expectant Mother or a Person Who is Ill

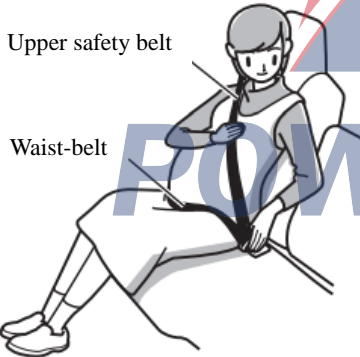

 **WARNING**

- An expectant mother or a person who is ill riding in the vehicle must also wear a seat belt. In light of the risk that the seat belt will apply pressure to the abdomen, chest and shoulders in the event of a collision, however, an expectant mother or a person who is ill should get advice from a physician beforehand.
- An expectant mother should use a three-point seat belt.
 - An expectant mother should position the lap belt snugly as low as possible on the hips (not across the abdomen). Also, she should fasten the shoulder belt so it rests on her chest, not on her abdomen.
 - Unless the seat belt is correctly worn, it may dig into the abdomen in the event of hard braking or a collision, harming not only the expectant mother but also the unborn child, putting them both in danger of serious injuries or death.

Carrying Children→Refer to page 2-12

Carrying Children

Using Seat Belts with Children

WARNING

- The vehicle's seat belts are designed for adults. If a seat belt touches a child's neck or chin, or does not rest across his/her hips, or who is less than six years old, use a baby seat, child seat or junior seat. If the seat belt were used as it is, it could apply intense pressure to the child's abdomen in the event of a collision. A small child who is not able to sit up by him/herself must be placed in a child seat.

NOTE

- The appropriate type of baby seat, child seat or junior seat and the proper installation for it depend upon the weight and height of the child.
It may not be possible to correctly fit certain child seats depending on their shapes. Be sure to use a child seat that is suitable for the vehicle.
* For detailed instructions, see the instruction manual supplied with the baby seat, child seat or junior seat.

POWERSTAR Seat Belt → Refer to page 3-17

Do not Leave a Child Alone in the Vehicle

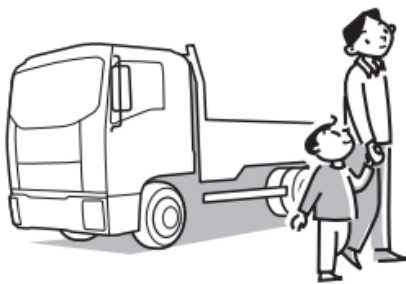

 WARNING

- When you leave the vehicle, take the child with you. If you leave the child alone in the cab, the child could interfere with things, causing vehicle movement, a fire or some other accident. Also, the cab inside could become dangerously hot when heated by the sun.

Do not Allow a Child to Put His/Her Head or Hands out of the Window



 WARNING

- Regardless of whether the vehicle is moving or stationary, you must never allow a child to put his/her head, hands, or other body parts out of the window. Allowing such behavior would be dangerous because the child could hit an obstacle.

An Adult must Open, Close, and Lock the Door for a Child



 WARNING

- To protect the child from the danger of getting his/her hands and head trapped, an adult must open, close and lock the door for the child. Be careful that the child does not interfere with the power window switches and get his/her hands or head trapped in the window. While a child is in the cab, be sure to control the power windows using the power window switches beside the driver's seat.

Opening and Closing Doors→Refer to page 3-4

Electric Windows→Refer to page 3-6

Driving

Check around the Vehicle before Starting the Engine

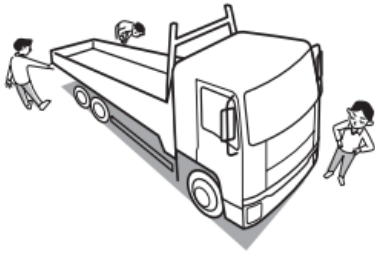

Before pulling away, perform a thorough safety check, making sure there are no children or obstructions around the vehicle. Because the rearview mirror has dead angle, it may not be safe when viewing only by the rearview mirror.

WARNING

- Before starting the engine, make sure there is no flammable material under or around the vehicle. The presence of any such material could lead to a fire.
- Pay attention to exhaust gas temperature during idling and especially while using PTO.

Engine Starting Method → Refer to page 4-4

Be Careful about Exhaust Emissions

WARNING

- Exhaust emissions contain carbon monoxide, which is colorless, odorless and poisonous. If you inhale exhaust emissions, you may suffer carbon monoxide poisoning.
- Do not keep the engine running for any length of time in a place that is poorly ventilated. It is particularly dangerous to run the engine in a garage or other indoor place that could easily fill with exhaust gases because you could suffer carbon monoxide poisoning.
- Inspect the exhaust pipe from time to time. If you notice any abnormality (for example, a damaged joint, or a hole or crack caused by corrosion), have checks and maintenance performed by the nearest Isuzu Supplier. Continuing to use the vehicle without having the defect repaired would be dangerous because exhaust gases could get into the cab and cause carbon monoxide poisoning.
- If exhaust gases get into the cab, completely open all of the windows and place the inside/outside air selector of the heater or air conditioner to outside air. Promptly have checks and maintenance performed by the nearest Isuzu Supplier. Continuing to use the vehicle without having the defect repaired would be dangerous because exhaust gases could get into the cab and cause carbon monoxide poisoning.

Starting the Engine



CAUTION

- Make sure the parking brake lever is firmly pulled, make sure the gearshift lever is in "N", and fully press the clutch pedal before starting the engine.
- Be sure to sit in the driver's seat to start the engine. If you are not sitting in the driver's seat (if, for example, you reach through the window or through the door opening), you cannot check the gearshift lever position. If you start the engine with the transmission in any position other than "N", the vehicle would move.

Engine Starting Method → Refer to page 4-4

If the Vehicle Has Not Been Driven for a Long Period



ADVICE

- Before using a vehicle that has not been driven for a long period, check the engine and transmission for oil leakage, and make sure the oil is at the required levels. If there is insufficient oil, it will not adequately reach and lubricate components, and a breakdown will result.
- For the vehicle which has not been used for more than one year, please replace the urea before use (AdBlue®). Otherwise, the urea SCR system will be in failure.
- Start the engine and allow it to idle for at least five minutes. Check for abnormal noises. Please refer to "Engine Starting Method" on page 4-4 for engine warming-up.



NOTE

[AdBlue®]

- AdBlue® is a registered trademark of German Automobile Industry Association (VDA).

Recommendations for Warming Up the Engine



The engine is sufficiently warmed up when the needle of the engine coolant temperature gauge starts to move.



ADVICE

- Please set the neutral gear during engine warming-up. In case of engine warming-up not at neutral gear, it may damage to transmission or the vehicle running.
- Do not rev the engine or quickly accelerate before the engine has sufficiently warmed up (in other words, when the engine is cold). Oil would not have adequately reached and lubricated components, so a breakdown would result. The exhaust pipe becomes extremely hot while the engine is idling. Before warming up the engine, make sure there is no flammable material (for example, grass, waste paper, oil or old tires) near the exhaust pipe.

Do not Run the Engine in a Garage



WARNING

- Running the engine in a poorly ventilated place can lead to carbon monoxide poisoning. Start and warm up the engine only in places that have good ventilation.

Do not Forget to Release the Parking Brake



ADVICE

- Pulling away with the parking brake still applied can damage the brake system.
- Make sure that the parking brake has been released before moving away.

Parking Brake Lever → Refer to page 4-75

Parking Brake Warning Lamp → Refer to page 4-40

Pulling Away in a Manual Transmission Model



ADVICE

- Pull away gently in second gear or lower (first gear on a slope). Pulling away in a high gear, pulling away rapidly or slipping the clutch for a long time while pulling away would damage the clutch.



POWERSTAR

Appropriate Gearshifts



ADVICE

- Downshifts are performed for two main purposes:
 - For engine braking on a steep and/or long downward slope.
 - For responsiveness and economy on an uphill slope

[Cautions for downshifts]

- Allowing the engine to overrun can result in engine damage. Do not allow the engine to overrun when downshifting.

To reduce the gear, please reduce one gear at each time. Otherwise, the transmission may be in failure.

[Driving uphill]

- Downshift early to avoid heavy engine load.

[Driving downhill]

- In principle, you should use the same gear(s) that you used to drive up the hill. Drive at a speed that does not cause the engine to overrun (exceed its r/min limit) and the tachometer needle to enter the red zone.

Drive at a speed that does not cause the tachometer needle to enter the red zone.

Parking Brake Lever → Refer to page 4-75

Parking Brake Warning Lamp → Refer to page 4-40



NOTE

[What is engine brake?]

- Engine brake is the braking effect that occurs when you release the accelerator pedal while driving. The lower the gear, the stronger the engine brake.

Never Stop the Engine While Driving



 **ADVICE**

- Do not place the ignition switch in any position other than "ON" while driving.
- If the engine stops while the vehicle is moving, the brakes would work poorly, and the steering wheel and clutch pedal would become extremely stiff and hard to operate. Also, the engine could be damaged.
- Stopping the engine while driving would be extremely dangerous because the warning lamps, indicator lights and other electrical circuitry would completely stop working.
- Placing the ignition switch in the "LOCK" position while driving would be extremely dangerous because the key could come out, causing the steering wheel to lock so that you could not turn it.

Steering Wheel → Refer to page 4-62

Do not Use the Bed While the Vehicle is Moving

 **CAUTION**

- It is not possible to hold a person's body in position on the bed. Using the bed while the vehicle is moving would be dangerous because the occupant of the bed could be thrown out of the bed in the event of a collision or hard braking.

Driving Down a Long Slope

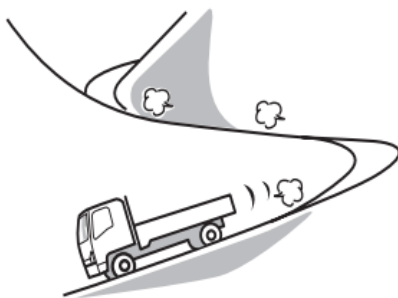

When driving down a long slope, select an appropriate gear to take advantage of engine brake and use the exhaust brake together with the foot brakes.

Using the exhaust brake and low-gear engine brake reduces the workload on the foot brakes and yields greater braking force. However, please pay attention to the engine operation at overspeed.

 **ADVICE**

- Frequent use of the foot brakes can cause brake fade, resulting in reduced brake effectiveness. Even so, use the foot brakes appropriately to prevent engine overrun.
- Do not adjust the exhaust brake valve.



NOTE

[What is engine brake?]

- Engine brake is the braking effect that occurs when you release the accelerator pedal while driving. The lower the gear, the stronger the engine brake.

[What is brake fade?]

- Frequent use of the brakes can cause the brakes to overheat so that the frictional force of the friction surface decreases and the brakes become less effective than normal. This phenomenon is called brake fade.

[What is an engine overrun?]

- An engine overrun is an engine-speed increase that causes the tachometer needle to enter the red zone.

Running Uphill and Downhill→ Refer to page 6-3

Driving in Bad Weather (Rain, Icy Roads, Snowy Roads, etc.)



CAUTION

- In bad weather, visibility is reduced and slippery road surfaces increase stopping distances. Drive more slowly than you would in good weather. Also, avoid sharp turns of the steering wheel and hard braking. Use engine brakes together with the foot brakes to decelerate. Using the exhaust brake on a slippery road surface could cause the tires to slip. Avoid using the exhaust brake in such conditions.



ADVICE

- There is a risk of hydroplaning, particularly where water tends to collect on the road surface. Drive at speeds that allow you to stay in complete control.
- If you cannot avoid driving on a flooded road, first check the depth of the water and then drive through the water at a slow, constant speed.



NOTE

[What is hydroplaning?]

- If a vehicle is driven at high speed on a road that is covered with water, a layer of water can form between the tires and road surface, causing the tires to lose their grip and slide across the water. This phenomenon is called hydroplaning. It is dangerous because it makes the steering wheel and brakes useless.

When the Vehicle Has Been Driven on a Flooded Road or Washed

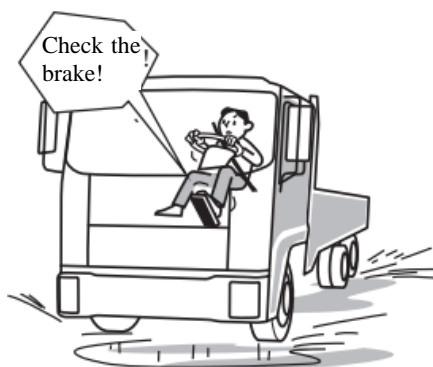

CAUTION

- If the vehicle must be driven on a flooded road or is parked in an area that becomes flooded, promptly have your Isuzu Supplier perform a check for the following points:
 - Engine damage due to water ingress
 - Shorting of electrical components
 - Effectiveness of the brakes
 - Water ingress or damage to drum brakes, or wheel parking brake chamber
 - Clutch release bearing (When water influx is suspected, replace release bearing)
 - Oil level and degradation (cloudiness) of the engine, transmission, differential and transfer case
 - Greasing of each components (lubrication)
- If the vehicle must be driven on a flooded road, is washed, or is parked in an area that becomes flooded, water can get into the brakes and reduce their effectiveness. If the brakes do not work well afterward, drive slowly and gently press the brake pedal several times until the brakes dry out and start working normally.

POWERSTAR

Sidewinds



ADVICE

If the vehicle catches a sidewind and drifts sideways, firmly grip the steering wheel, decelerate to a speed that allows you to stay completely in control and make a directional correction. The vehicle may catch strong sidewinds in the following situations:

- Emerging from a tunnel; driving over a bridge, driving on an embankment or driving through a cutting;
- Being overtaken by a large truck or bus;
- Overtaking a large truck or bus.

Dealing with a Blowout or Flat Tire While Driving



WARNING

- If you feel any abnormality in a tire while driving, immediately stop in a safe place. If you continue to drive on a flat tire, undue force would be applied to the wheel bolts, possibly causing the bolts to break and the wheel to come off.



ADVICE

- If a blowout or flat tire occurs while you are driving, calmly grip the steering wheel and gradually apply the brakes to decelerate. (Hard braking would be dangerous because it could cause the steering wheel to be pulled to one side.) Stop the vehicle in a safe place, and change the tire.

Spare Tire → Refer to page 7-88

Handling the Jack → Refer to page 7-5

Tire → Refer to page 7-72

If the Underside of the Vehicle Receives a Hard Bump



ADVICE

- If the underside of the vehicle receives a hard bump, stop in a safe place where the vehicle will not obstruct traffic and check for air leakage, fuel leakage and component damage. If any part of the vehicle is damaged or broken, promptly have the vehicle inspected and repaired by the Isuzu Supplier.

If a Warning Lamp or Indicator Lamp Comes On or Flashes

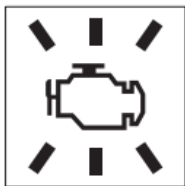

ADVICE

- If a warning lamp comes on or flashes, do not ignore it and keep driving. Be sure to take corrective action while referring to the explanation of the meters, warning lamps and indicator lamps.

When the Warning Lamp is On → Refer to page 8-17

When the Meter Shows Abnormal (Excluding Water Temperature Gauge) → Refer to page 8-23

Stopping and Parking



ADVICE

- Choose a flat place where stopping and parking are permitted and where the vehicle will not obstruct traffic. Firmly apply the parking brake and make sure the vehicle does not move. Remove all dirt from the vehicle's light lenses and reflectors to ensure that the vehicle can be seen from other vehicles.

Applying the Parking Brake



CAUTION

- Except in an emergency, do not apply the parking brake until the vehicle has come to a complete stop. Applying the parking brake before the vehicle has stopped can cause the tires to lock or the vehicle to spin, possibly causing an accident.

Parking Safely on a Slope

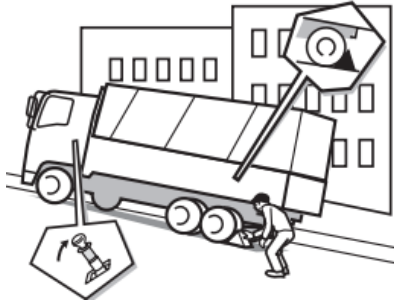

ADVICE

- As much as possible, choose level places to park and avoid parking on slopes. If you cannot avoid parking on a slope, firmly apply the parking brake and make sure the vehicle does not move. Apply chocks to the wheels for safety. Also, leave the vehicle in gear to further ensure that it will not move.

Napping in the Vehicle



WARNING

- It is possible to unconsciously move the gear lever and step the accelerator pedal so as to cause accident. Therefore, please use sleeper while taking a nap.

Keep Flammable Material away from the Vehicle



CAUTION

- The exhaust pipe is extremely hot immediately after vehicle operation. Before parking, make sure the area is free of flammable material (for example, grass, waste paper, oil or old tires). Take particular care when parking in a garage.
- Use caution concerning hot exhaust gases while the engine is idling. Be particularly careful when the power take-off (PTO) is operating (if your vehicle is equipped with a PTO) while the engine is idling.

Do not Touch the Gearshift Lever While the Vehicle is Stationary **WARNING**

- Do not touch the gearshift lever while the vehicle is stationary with the engine idling. If you touch the gearshift lever at this time, a gear could be selected and the vehicle could move even with parking brake applied. The risk of knocking against the gearshift lever and causing an accident is particularly great when you move in or out of your seat.

Be Sure to Have the Engine Running When the Vehicle is Moving **WARNING**

- When the engine is not running, the power steering system does not work so the steering wheel is hard to turn. Also, the braking system does not work so there is little braking ability. If you coast down a slope without the engine running, you would not be able to properly control the vehicle and could have an accident.

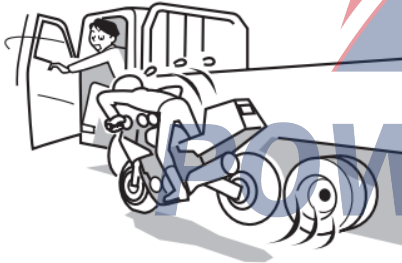
Look around before Opening a Door **CAUTION**

- Before opening a door, check the area around the vehicle by looking forward, rearward and to the sides. If you suddenly open a door without checking the surrounding area, the door could hit by a vehicle following you or a pedestrian.

Leaving the Vehicle



WARNING

- When leaving the vehicle, be sure to apply the parking brake, stop the engine and lock the doors. Do not leave valuables where they can be seen from outside the vehicle.
- If you are traveling with a child, do not leave the child alone in the vehicle. If the child touches the controls or equipment, an accident could occur. (For example, the vehicle could move or a fire could start.) Also, the cab inside could become dangerously hot when heated by the sun.
- Do not leave eyeglasses or a lighter in the vehicle. If the cab inside becomes hot, a lighter left there could explode and plastic eyeglass lenses or frames could deform or crack.

Metallic Plinking Sound from the Muffler

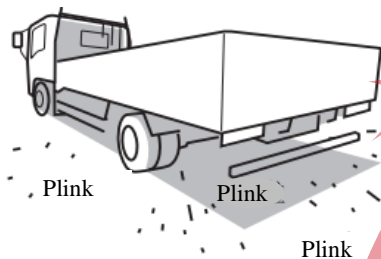

NOTE

- Immediately after stopping the engine, you may hear a metallic plinking sound from the muffler. This sound occurs as the muffler cools down and contracts. It does not indicate an abnormality or breakdown.

Starting to Drive When the Vehicle Has Been Parked

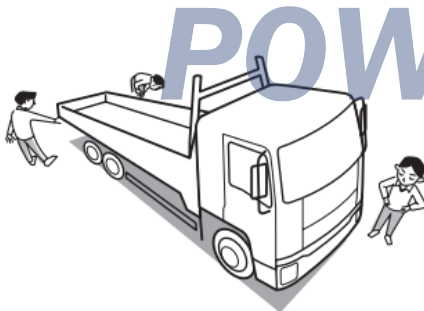

POWERSTAR

Before pulling away, perform a thorough safety check, making sure there are no children or obstructions around the vehicle.

Reversing

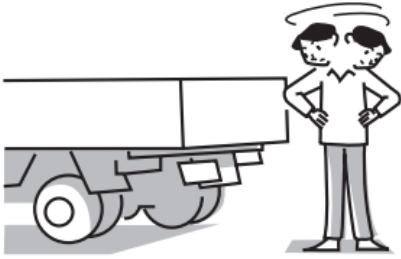

If you cannot see the area behind your vehicle well enough to confirm it is safe to back up, get out of the vehicle and check behind it.

Pulling away After a Temporary Stop

 CAUTION

- **Make it a habit** to look around and confirm it is safe to pull away after a temporary stop (at traffic lights, for example).

POWERSTAR

Staying Safe

When the Engine Coolant is Hot



WARNING

- Do not loosen or remove the radiator sub-tank cap while the engine coolant is hot. Doing so would be dangerous because steam and hot air would shoot out.

Engine Coolant → Refer to page 7-56

When the Muffler and Exhaust Pipe are Hot



CAUTION

- When the engine is running and immediately after vehicle operation, the urea, SCR, muffler and exhaust pipe are extremely hot. Be careful not to inadvertently touch them when working near them (for example, tilting the cab or operating an attachment).

POWERSTAR

Pay Attention to Gas Lighter



WARNING

- Do not place a gas cigarette lighter with its operating parts exposed in the glove compartment or a similar place, or drop and leave it on the floor or in a gap in the seats.

After Using the Ashtray



 **WARNING**

- Please pay attention to close the ashtray. Burn state cigarette ash may cause a fire.
- Please contain excessive cigarette ends in ashtray. Please never contain the inflammables.
- Never throw the burning cigarette or cigarette end out of the window. It will not only pollute the road and ambient environment but also cause a fire.

Ashtray→ Refer to page 5-18

Do not Attach Accessories to the Windshield or Windows



 **WARNING**

- Do not attach ornaments, films or other accessories to the windshield or windows. They would impair visibility. Also, any plastic suction cups used to attach accessories could cause a fire or other accident by acting as lenses.

Do not Use a Mobile Telephone While Driving



 **WARNING**

- Drivers should never use mobile telephones or car phones in any mode while driving. Doing so is dangerous. If you are driving and you wish to use a mobile telephone, first stop the vehicle in a safe place.
- Using a mobile telephone while driving could result in an accident because you would not be paying full attention to your surroundings.

Using the Jack

 **WARNING**

- Jacking up a vehicle on a slope or soft ground is extremely dangerous. Be sure to jack up the vehicle on a firm, level surface.
- Set the jack in the correct position. Do not forget to first apply the parking brake and place chocks around the wheels.
- When a rear wheel is jacked up, the parking brake has no effect. Failing to first put chocks in the correct places would be dangerous because the vehicle could move.
- On a differential lock model or a limited slip differential model, any transmission of torque to the rear wheels can make the vehicle move even if one rear wheel is off the ground. If any rear wheel is on the ground, do not apply torque to the rear wheels.
- Do not look under the vehicle or get under the vehicle while the vehicle is only supported by jacks. Doing so is dangerous. Always use the vehicle support stand.

Tools → Refer to page 7-4
 Handling the Jack → Refer to page 7-5

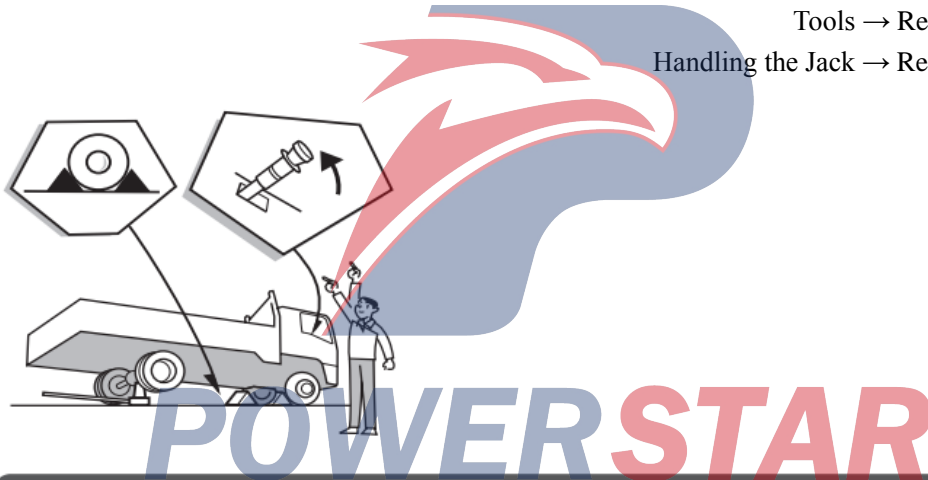

When the Battery Goes Flat

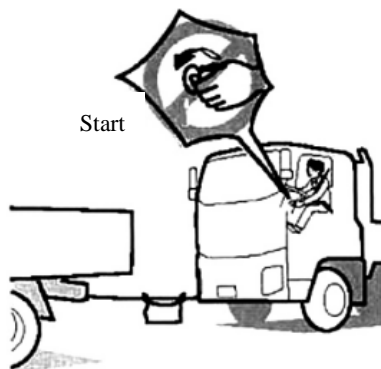
 **CAUTION**

- Do not try to start the engine by pushing or towing the vehicle. You could damage the engine.

When the Battery Goes Flat → Refer to page 8-12

Preventing Breakdowns

Do not Rest Your Foot on the Clutch Pedal While Driving



 ADVICE

- If you rest your foot on the clutch pedal while driving, the clutch could partially disengage without you realizing it, causing the clutch plates to wear and the clutch to slip. Also, do not slip the clutch as a way to hold the vehicle in position (instead of using the brakes) on, for example, an uphill road.

Is the Engine Oil Dirty?



 ADVICE

- The engine oil performs the following important functions:
 - It prevents engine parts from becoming worn.
 - It cools engine parts.
 - It cleans engine parts.
 - It seals the combustion chambers and prevents rust.
 - Replace the engine oil at regular intervals.

Routine Inspection (before Driving) → Refer to page 7-33

Engine Oil → Refer to page 7-38

Maintenance Data List → Refer to page 7-15

Do not Climb onto the Engine



ADVICE

- Do not step on the engine or climb onto it. You could cause an engine failure by, for example, damaging the cylinder head cover or various connectors.

Do not Leave the Steering Wheel Fully Turned for a Long Time

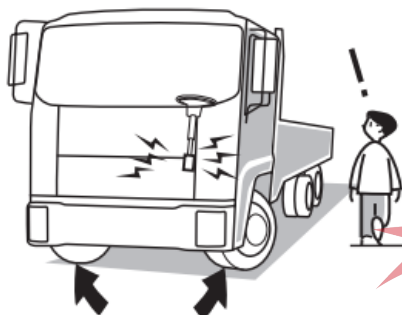

WARNING

- If you leave the steering wheel fully turned for a long time, the oil in the power steering oil pump would become extremely hot. This would cause poor lubrication, oil tank damage and seal deterioration, leading to power steering oil pump damage, power steering unit damage and power steering hose damage. As a result, the steering wheel could become extremely hard to turn and a fire or other accident could occur.

Make Sure the Vehicle is Inspected at Regular Intervals

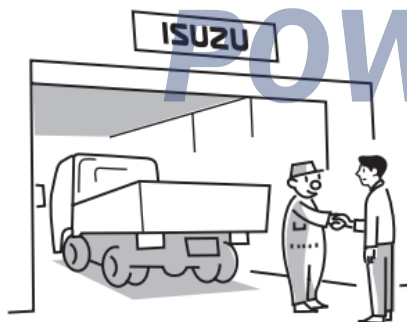

ADVICE

- Inspections and maintenance enable you to use the vehicle with peace of mind. They also extend the vehicle's service life.

Routine Inspection (before Driving) → Refer to page 7-33

Engine Oil → Refer to page 7-38

Maintenance Data List → Refer to page 7-15

When to Visit an Isuzu Supplier

Do not Modify the Vehicle

 CAUTION

- Attaching parts that are not suitable for the vehicle's performance and functions could lead to a breakdown or accident. For adjustments (for example, engine adjustments) and equipment installation, consult your Isuzu Supplier.
- If you wish to attach accessories to the vehicle, consult your Isuzu Supplier.



Have Engine Adjustments Made by an Isuzu Supplier



 CAUTION

- Do not make engine adjustments yourself. Be sure to consult your Isuzu Supplier.

Electric Welding



ADVICE

- Careless electric welding of vehicle parts can cause welding current to flow back through the vehicle's ground circuit and damage electrical and electronic parts so that they do not function normally. Whenever electric welding is necessary, consult your Isuzu Supplier.

Replacing Tires and Wheels



CAUTION

- Consult your Isuzu Supplier before replacing tires or wheels. Never use wheels that are not designed for the vehicle, tires of different types at the same time or tires that are not the specified size.
- Doing so would impede safe vehicle operation.

Tires → Refer to page 7-72

Changing a Tire (ISO 10-bolt Wheels) → Refer to page 7-80

Installing Electrical Equipment

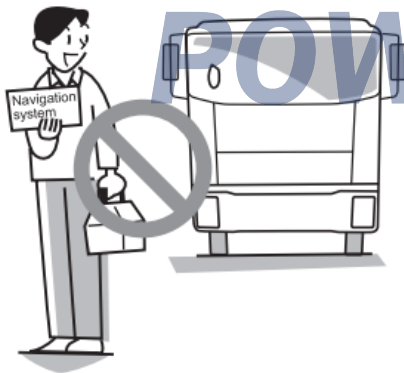

CAUTION

- Inappropriate installation or removal of audio, radio or other electrical equipment can adversely affect other electrical equipment and cause a breakdown or fire. In addition, it can cause abnormal expansion of the SRS airbag, which is very dangerous. Be sure to have electrical equipment installed or removed by your Isuzu Supplier.



ADVICE

[Installation of radio equipment]

- Do not install any unauthorized radio set, or any radio set or antenna that does not comply with relevant standards.
- Noise from the radio set could cause electromagnetic interference with the vehicle's electronic equipment and other systems, resulting in a vehicle breakdown or in a malfunction of electronic equipment.
- Consult your Isuzu Supplier if you wish to install radio equipment.

About Urea SCR System

Urea SCR system is designed to clean up emissions of nitric oxide (NO_x) in tail gas. Use the urea (AdBlue®) as a reducing agent for hydrolytic decomposition in hot gas to produce ammonia gas. Use the generated ammonia gas for reduction action with nitric oxide (NO_x) to produce the nitrogen and water purification system.



CAUTION

- Do not touch the water from muffler. If your skin touches the waste water, please wash your skin with clear water.



ADVICE

- Do not modify exhaust pipe, muffler or movable urea tank. Otherwise, it may affect the purification performance of tail gas. If the modification or movement is unavoidable, please consult the ISUZU supplier.



NOTE

- This vehicle is provided with gas clean up function, so its exhaust gas is different other diesel engine vehicles.

【AdBlue®】

- AdBlue® is a registered trademark of German Automobile Industry Association (VDA).

Operation of Urea (AdBlue®)



CAUTION

- There is no harm even if the human body touches the urea (AdBlue®). However, in a few cases the inflammation may be caused upon the different physique. In this case, the following treatment shall be done.
 - Please wash your skin with clear water if your skin touches the solution due to carelessness. It is possible to cause skin irritation to those persons with sensitive skin.
 - In the case of eating by mistake, first drink one or two cups of water or milk and then see a doctor.
 - When the solution enters your eye, immediately wash your eye with a large amount of water for more than 15 minutes and then see a doctor.

Whether to Use the Specified Urea (AdBlue®)

- Please use the urea (AdBlue®) as designated by Qingling Motor Co., Ltd.
 - For urea (AdBlue®), please use the solution (AdBlue®) which can conform to ISO (International Organization for Standardization) AUS 32 ISO 22241 specification.

Storage of Urea (AdBlue®)

- Seal the urea (AdBlue®) in a container to avoid the water evaporation and store such container in a shady and well-ventilated place.
- For the stored urea (AdBlue®), its useful life may be different upon the room temperature of storage place. Please consult the supplier for details.



NOTE

- Even if the urea (AdBlue®) has been frozen, its quality will remain unchanged after it is unfrozen. Do not use the frozen urea.
- When storing or carrying the urea (AdBlue®), please use the container which is used when purchasing the urea (AdBlue®). If other containers must be used, however, please use a special container, clean polyethylene resin (PE) tank without water, garbage or other foreign matters or stainless container.

Filling the Urea (AdBlue®)



WARNING

- Do not contain other liquid than urea (AdBlue®) in urea tank.
- When filling the urea (AdBlue®), the following operations may cause a fire or the fault of urea SCR system.
 - Thin the urea by water.
 - Blend the urea with gasoline or kerosene.
- If other liquid other than the designated urea (AdBlue®) is filled, it is necessary to check the urea SCR system. Immediately go to ISUZU supplier for inspection and maintenance.



CAUTION

- In a few cases you can smell the pungent odor while uncovering the urea tank. Never smell the odor at filler port.



ADVICE

- Please pay attention to the urea level. Please add the urea (AdBlue®) as soon as possible when reaching a low level. The engine can not start when the urea (AdBlue®) is used up.
- Please pay attention to the urea level over the "F" Line on meter. During running, the urea (AdBlue®) may leak from vent pipe. In addition, the frozen urea (AdBlue®) may damage the sensor component.
- Please don't step or sit on the urea tank. It may damage to the urea tank, pipeline or sensor component. When turning ignition switch to the position "LOCK", the SCR system will continue the operation for about 1 minute. Please take out the battery or the connector of electrical system, then wait for 3 minutes and continue the operation when inspecting or repairing SCR.



NOTE

- After the engine stops, sometimes you may hear the operation sound of urea tank or urea supply unit. This is normal because such sound shows that the urea (AdBlue®) is flowing back to the urea tank.

Scrapping the Urea (AdBlue®)

Please don't scrap (AdBlue®) to lake, sea or river, etc. Please scrap the urea in a light way.

Vehicle with Speed Limiter (Speed Control Device)

Characteristics of Speed Limiter



CAUTION

- Due to the lack of brake control, it should be noted that the downhill speed may exceed the set speed.
- The speed limiter may not operate due to the change of tire type. Therefore, please go to the ISUZU supplier for adjustment.



NOTE

- The speed limiter is a device to limit speed within set value by controlling the fuel injection quantity even if the accelerator pedal is stepped.

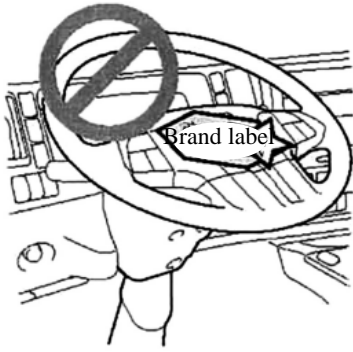

WARNING

- In case of improper modification or installation, the safety belt with pretensioner may not operate normally.
- If the irregular steering wheel is used or the handle is stuck with brand label, the wrong operation or the peeling of brand label may cause the dangerous consequence.
- The following operations need special treatment, so consult ISUZU supplier. The safety belt with pretensioner will operate suddenly to be tensioned or get loose so as to cause personal injury. In addition, it will produce bad effect on the system, such as bad contact or fault.
 - When the steering wheel, dashboard, center console, clutch pedal, brake pedal peripherals and driver's safety belt are repaired or replaced;
 - When the safety belt with pretensioner is repaired, replaced or discarded or the vehicle with safety belt and pretensioner is discarded;
 - When the audio equipment or necessities or on-board equipment is installed;
 - When the vehicle front part and the metal plate of driver cab are coated.

POWERSTAR